



T7F-2.4GHz



INSTRUCTION MANUAL
for RadioLink T7F-2.4GHz
7-channel, FHSS
for Airplanes/Helicopters

TABLE OF CONTENTS

Introduction	3
Contents and specifications	3
Glossary	3
Introduction to the T7F-2.4GHz system	4
Transmitter controls and descriptions	4
Radio installation	6
Receiver and servo connections	8
LCD and Programming controls	9
Programming the T7F-2.4GHz radio	11
MODL Model select function	11
MODL Model select function	11
REST Data reset function.....	11
ACRO/HELI Model type select function.....	12
Model name settings.....	12
REVR Servo reversing.....	12
D/R Dual Rate and Exponential settings	13
D/R Dual Rate settings.....	13
EXPO Exponentials	13
EPA End Point Adjustments.....	13
TRIM Trim Settings.....	14
(ACRO functions)	
N-TH Normal Throttle Curve.....	15
PMX1 Programmable Mixer #1.....	15
PMX2 Programmable Mixer #2.....	15
FLPR Flaperon mixing.....	16
FLTR Flap trim.....	17
V-TL V-tail mixing.....	17
ELVN Elevon mixing.....	18
AUX Auxiliary function.....	19
(HELI functions)	
N-TH Normal Throttle Curve.....	20
N-PI Normal Pitch Curve.....	20
I-TH Idle-Up Throttle Curve function.....	20
I-PI Idle-Up Pitch Curve function.....	21
HOLD Throttle hold function.....	21
REVO Pitch - rudder mixing function	22
GYRO Gyro mixing function.....	22
SWSH Swashplate types selection & Swash AFR.....	23
AUX Auxiliary function.....	24
Flow chart (ACRO)	25
Flow chart (HELI)	26
Other T7F-2.4GHz functions	27
Trainer function.....	27
Adjustable-height control sticks.....	28
Changing the stick mode.....	28
Flight preparation	28
Model Data Recording Sheets (ACRO)	29
Model Data Recording Sheets (HELI)	30

INTRODUCTION

Thank you for purchasing the RadioLink T7F-2.4GHz FHSS digital proportional R/C airplane/helicopter system. If this is your first “computer” radio, rest assured that it is designed to make initial setup and field-tuning of your airplane/helicopter easier and more accurate than using a “non-computer” radio. Although this is a beginner or sport system with the requirements of those flyers in mind, in order to make the best use of your RadioLink T7F-2.4GHz and to operate it safely, you must carefully read all of the instructions.

Suggestion: If, while reading the instructions, you are unclear of some of the procedures or functions and become “stuck,” continue to read on anyway. Often, the function or procedure will be explained again later in a different way, providing another perspective from which to understand it. Another suggestion is to connect the battery, switch and servos to the receiver and actually operate the radio on your workbench as you make programming changes. Then, you'll be able to see the effects of your programming inputs.

CONTENTS AND SPECIFICATIONS

Transmitter: T7F-2.4G

T7F-2.4GHz Transmitter of FHSS system
Transmitting on 2.4GHz band
Operating system: 2-stick, 7-channel system
Power supply: 12V battery (8 pieces 5# batteries)
Current drain: 80mA
Weight: 560g (battery not included)

Receiver: R7EH

7 channel receiver
Receiving on 2.4GHz band.
Power requirement: 4.8V- 6V
Weight: 11g

GLOSSARY

It will be helpful to understand the following terms before reading the rest of the manual. The terms are not in alphabetical order, but are in a logical order that prepares the reader for understanding the next term.

Reversing (servo reversing) - A function that allows the user to determine the direction of response of each servo. If, after hooking up the servos, a control on the model responds in the wrong direction, the user may change the servo's direction so the control responds correctly.

Throw - When speaking of a control surface (such as an elevator or aileron), the throw is the distance the surface moves. Control surface throw is usually measured at the trailing edge of the surface and is expressed in inches or millimeters. The model in the diagram has 1/2" [13mm] of up elevator throw. Throw can also refer to the distance a servo arm (or wheel) travels.

Dual rate (D/R) - On the T7F-2.4GHz the dual rate switch allows you to instantly switch, in flight, between two different control throws for the aileron, elevator and rudder. Often, different control throws are required for different types of flying. (“Low” throws may be required for flying at high speeds where the model's response becomes more sensitive, and “high” throws may be required for aggressive aerobatic maneuvers or landing or flying at lower speeds where the model's response becomes less sensitive.)

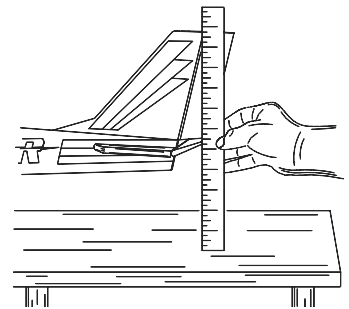

End point adjustment (E.P.A.) - Sets the overall, maximum distance the servo rotates in either direction. (No matter where the dual rates are set, the servo will never travel beyond the limit set by the end point adjustment.)

Exponential - Normally, servos respond proportionally to control stick input from the transmitter (e.g., if the stick is moved halfway, the servo will move halfway). However, with “exponential,” the servo can be made to move more or less than initial stick movement (less servo movement is more common). Exponentials are commonly used to “soften,” or decrease initial servo travel for the ailerons, elevators and rudder. This way, initial control stick inputs from the pilot result in small servo movement for a smoother flying airplane.

(Dual rates adjust the amount of servo travel. Exponentials determine where most of the travel will occur.)

Mixing - Two (or more) servos can be made to operate together either by mechanically joining the wires (with a Y-connector) or by electronically “joining” them through programming functions in the transmitter. When servos are electronically joined via programming, they are said to be “mixed.” Unlike joining servos with a Y-connector, when servos are mixed electronically they can be made to move in opposition. Additionally, each servo's end points can be independently set.

INTRODUCTION TO THE T7F-2.4GHz SYSTEM

IMPORTANT!: Always turn on the transmitter first, then the receiver. When turning off the system, always turn off the receiver first. The object is never to have the receiver on by itself. Otherwise, the servos or control surfaces could be damaged, or in the case of electric-powered models, the motor may unexpectedly turn on causing severe injury.

Transmitter

ACRO mode: External switches operate dual rates (D/R), landing gear, and trainer cord or “buddy-box” capabilities. Programming features include servo reversing and E.P.A on all channels, dual rates, exponentials and programmable mixing. Additionally, any one of four, factory-set, preprogrammed “wing-type” mixers including flaperon, and V-tail, elevon mixing may be selected.

HELI mode: Dual rate (D/R), Idle up, Throttle hold, and Gyro sense can be operated by switch. Two different gyro senses can be set with RadioLink GY100 Gyro on gyro function of this transmitter. Programming features include servo reversing and E.P.A on all channels, dual rates, exponentials, throttle curve, pitch curve, throttle hold, and pit to rudder mixing(REVO). Additionally, any one of two, factory-set, preprogrammed “swashplate type” mixers, including three servo type 3-S, may be selected.

Transmitter controls

The diagram and explanations briefly describe the functions of the RadioLink T7F-2.4GHz transmitter. Full instructions on how to operate the controls are provided beginning on page 11.

Mode 1: Throttle on the right. Mode 2: Throttle on the left. (More on flight modes on page 28)

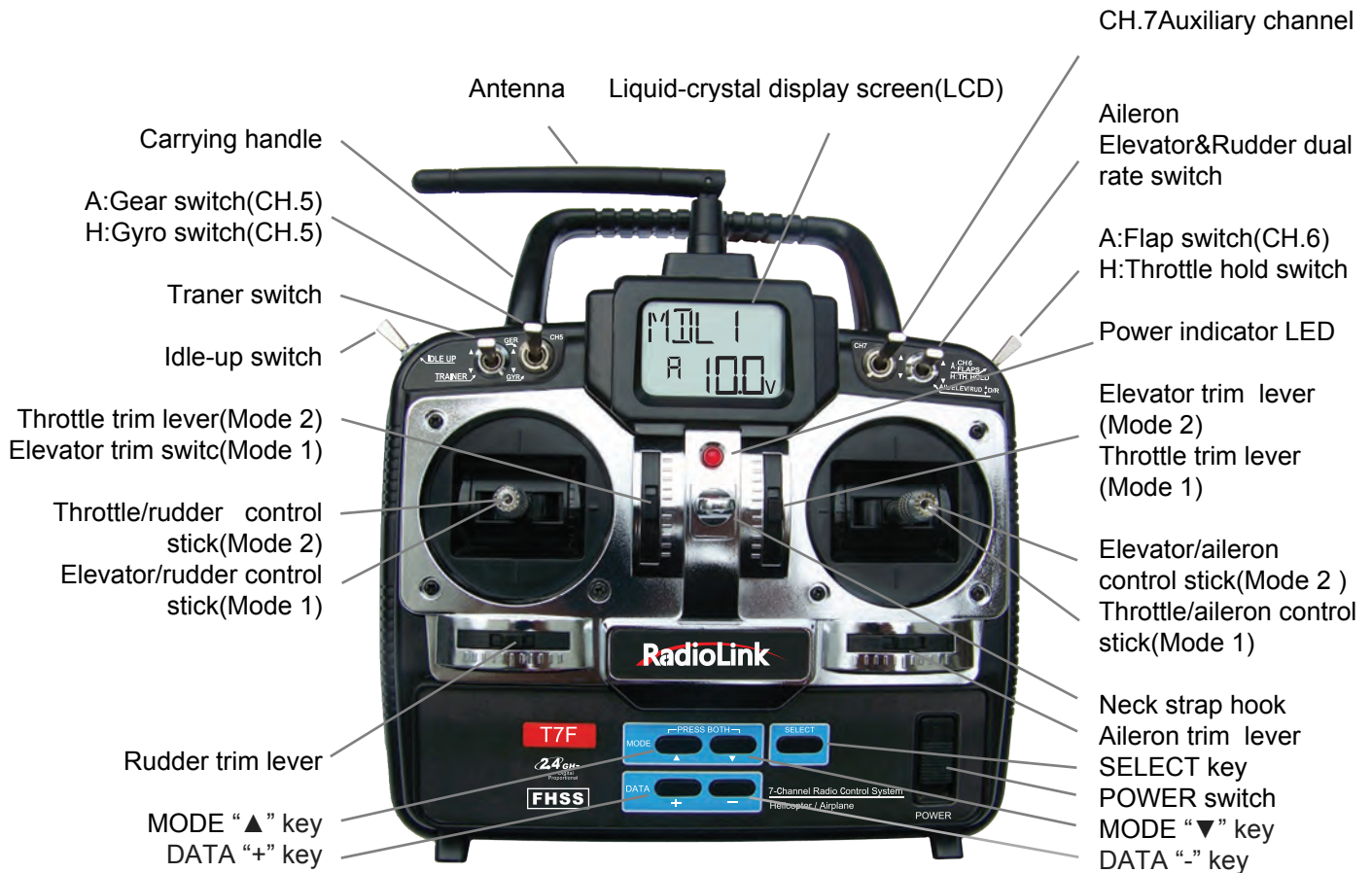

DESCRIPTIONS:

Aileron, Elevator and Rudder dual rate switch

Use this switch to “flip” between two aileron, elevator and rudder control throw settings. The throws can be set up however you prefer, but generally, when the switch is “up” the throws are greater (“high rate”) and when the switch is “down” the throws are less (“low rate”). This switch also flips between exponential rates (if used).

A: Flap switch/Channel 6 - This switch operates the servo connected to channel 6 in the receiver. If your model has flaps, this is the control used to operate them.

H:Throttle - hold switch - This switch operates to hold the engine in the idling position and disengage it from the Throttle Stick. It is commonly use to practice auto-rotation.

Neck strap hook - Mounting point for optional neck strap.

Aileron/elevator control stick - Operates the servos connected to channel 1 (aileron) and channel 2 (elevator) in the receiver.

Trim levers (all) - Used to shift the neutral or center position of each servo as labeled in the diagram. Once either trim lever is operated, the trim position is displayed on the LCD screen. Also once either edit key is operated, all trim positions are displayed sequentially on the LCD screen.

NOTE: The throttle trim lever is intended for fine tuning the throttle servo when the engine is at idle. Throttle trim does not affect the throttle servo when the throttle control stick is all the way up (so idle r.p.m. can be adjusted without affecting throttle settings through the rest of the stick movement).

Charging jack - Port for charging the transmitter batteries.

POWER switch-power on/power off

DATA “+” or “-” key - Used to change the values of the various functions displayed on the LCD screen

Liquid - crystal display screen (LCD) - Displays programming modes and values entered.

MODE “▲” or “▼” key - Used to scroll through and display the different functions.

Press MODE “▲” key to scroll to previous function menu.

Press MODE “▼” key to scroll to next function menu

SELECT key - Used to scroll the sub-menu for the current function.

Throttle/rudder control stick - Operates the servos connected to channel 3 (throttle) and channel 4 (rudder) in the receiver.

Trainer switch - Operates the trainer functions. To operate as a trainer switch the transmitter must be connected to another transmitter via. a trainer cord (available separately).

Idle - up switch - This switch operates to change the fight condition which sets the throttle curve and pitch curve of mid air maneuvers (rolls, loops, stall turns) and 3D flight.

A:Retractable landing gear switch/Channel 5 - Switch operates the servo connected to channel 5 in the receiver. If your model has retractable landing gear, this is the control used to extend and retract the gear.

H:Gyro switch/Channel 5 - You can connect the sense adjust connector to channel 5 of the receiver to operate the gyro, which has two different senses. Also if you use the RadioLink GY100 Gyro, two different gyro sense settings on the gyro function in this transmitter can be called by this switch.

Antenna - Radiates signals to the receiver. **NEVER** point at the model when flying!

RADIO INSTALLATION

Follow these guidelines to properly mount the servos, receiver and battery

Make certain the **alignment tab** on the battery, switch and servo connectors is oriented correctly and “keys” into the corresponding notch in the receiver or connectors before plugging them in. When unplugging connectors, never pull on the wires. Always pull on the plastic connector instead.

If any servo wires are not long enough to reach the receiver, servo extension wires (available separately) may be used.

Always mount the servos with the supplied **rubber grommets**. Do not over tighten the screws. No part of the servo casing should contact the mounting rails, servo tray or any other part of the airplane/helicopter structure. Otherwise, vibration will be transmitted to the servo causing premature wear and/or servo failure.

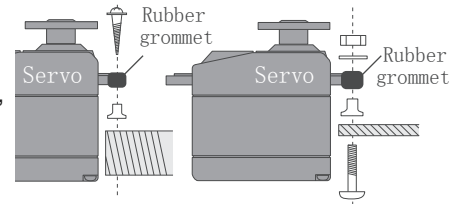

Note the small numbers (1, 2, 3, 4) molded into each arm on the 4-arm servo arms. The numbers indicate how many degrees each arm is “off” from 90 degrees to correct for minute manufacturing deviations from servo to servo.

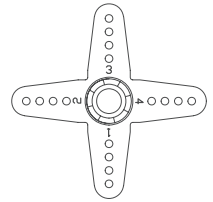

THE TRIMS ON THE RADIO SHOULD BE CENTERED.

To center the servos, connect them to the receiver and turn on the transmitter and receiver. Center the trims on the transmitter, then find the arm that will be perpendicular to the pushrod when placed on the servo.

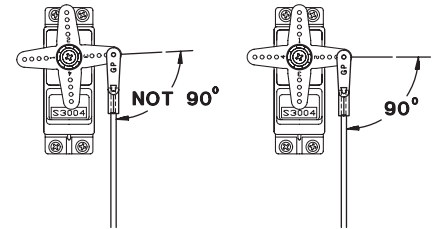

After the servos are installed, operate each servo over its full travel and check that the pushrods and servo arms do not bind or contact each other. Also make sure the controls do not require excess force to operate. If there is an objectionable buzzing sound coming from a servo, there is probably too much resistance in the control. Find and correct the problem. Even if there is no servo damage, excess battery drain will result.

To prevent the servo lead wires from being broken by vibration during flight, provide a margin so that the wire sticks out slightly and fasten it at suitable points. In addition, periodically check the wire during daily maintenance

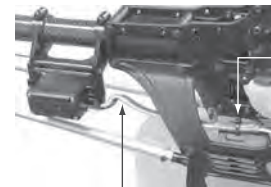

Fasten about 5-10cm from the servo outlet so that the lead wire is neat.

Margin in the lead wire.

Receiver's Antenna Installation:

To obtain the best results of function, please refer to the following instructions;

1. The antenna must be kept as straight as possible. Otherwise it will reduce the effective range.
2. Larger models can have large metal objects that can attenuate the RF signal. In this case the antenna should be placed at both sides of the model. Then the best RF signal condition is obtained at any flying attitude.
3. The antenna must be kept away from conductive materials, such as metal and carbon by at least a half inch. The coaxial part of the antenna does not need to follow these guidelines, but do not bend it in a small radius.
4. Keep the antenna away from the motor, ESC, and other noise sources as much as possible.

The receiver contains precision electronic parts. It is the most delicate radio component on-board the model and should be protected from vibration, shock and temperature extremes. To protect the receiver, wrap it in R/C foam rubber or other vibration-absorbing material. If appropriate, waterproof the receiver by placing it in a plastic bag and closing the open end with a rubber band before wrapping it in foam. If moisture enters the receiver, intermittent operation or a failure may result. Wrapping the receiver in a plastic bag also protects it from fuel and exhaust residue which, in some models, can work its way into the fuselage.

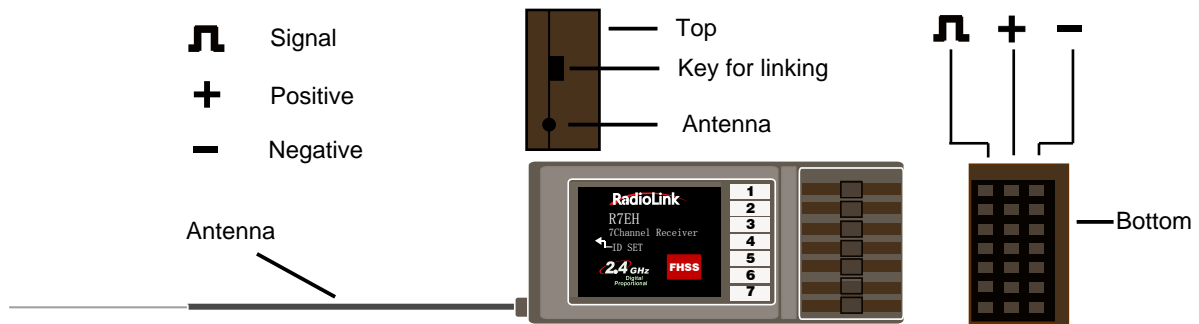

Transmitter Antenna

1. The transmitter antenna is adjustable so please make sure that the antenna is never pointed directly at the model when flying as this creates a weak signal for the receiver.
2. Keep the antenna perpendicular to the transmitter's face to create a better RF condition for the receiver. Of course this depends on how you hold the transmitter, but in most cases, adjusting the transmitter antenna so that it is perpendicular to the face will give the best results. Please adjust the transmitter antenna to the way you hold the transmitter.
3. NEVER grip the antenna when flying as this degrades RF quality.

Link Procedure

Each transmitter has an individually assigned, unique ID code. In order to start operation, the receiver must be linked with the ID code of the transmitter with which it is being paired. Once the link is made, the ID code is stored in the receiver and no further linking is necessary unless the receiver is to be used with another transmitter. When you purchased another R7EH, this procedure is necessary; otherwise the receiver will not work.

1. Place the transmitter and the receiver close to each other within one (1) meter
2. Turn on the transmitter.
3. Connect the 5V power line of ESC to the 3rd channel of receiver.
4. Press down the "ID SET" switch for more than one second, and release the switch. The receiver starts the linking operation. The LED of receiver blinks 12 times, then always green on signifies the success of linking.
5. Please confirm that the servos will now operate by your transmitter.

RECEIVER AND SERVO CONNECTIONS

Connect the servos to the receiver to perform the functions indicated:

Receiver Output Channel	Function	
	Aircraft(ACRO)	Helicopter(HELI)
1	Aileron-or-right flaperon-or-right eleven(for tailless models)	Aileron
2	Elevator-or-left ruddervator(for V-Tail models) -or-left elevon(for tailless models)	Elevator
3	Throttle	Throttle
4	Rudder-or-right ruddervator(for V-Tail models)	Rudder
5	Retractable landing gear	Gyro sensitivity
6	Flap-or-left flapron	Pitch
7	Auxiliary	Auxiliary

The diagram shown is for aircraft models only. Additional servos may have to be purchased separately

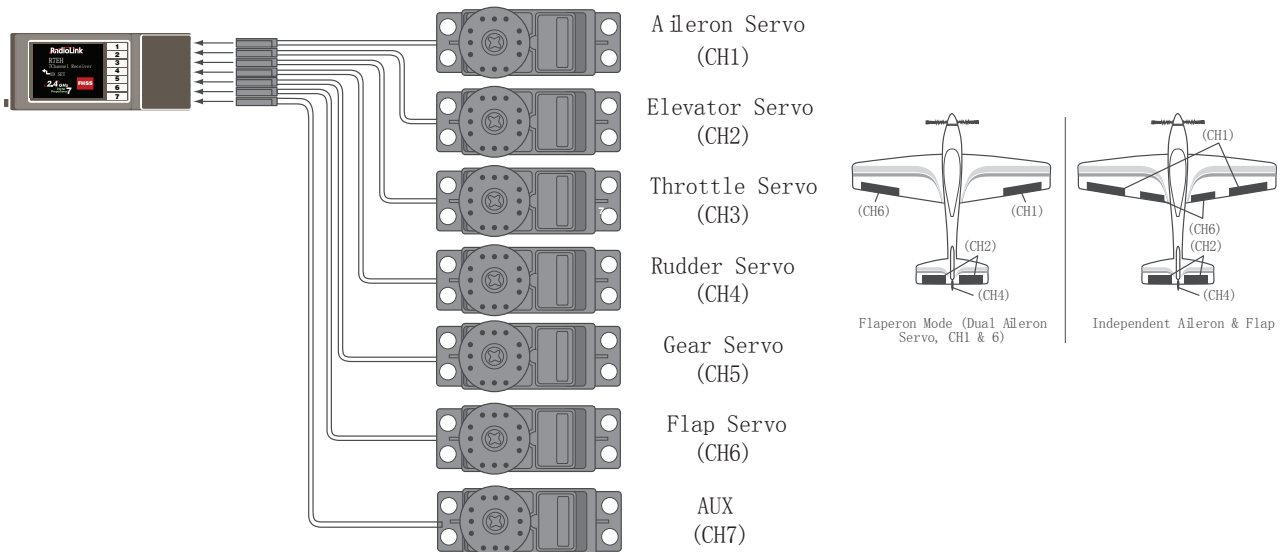

The diagram shown is for helicopter models only. It is necessary to buy an additional gyro separately

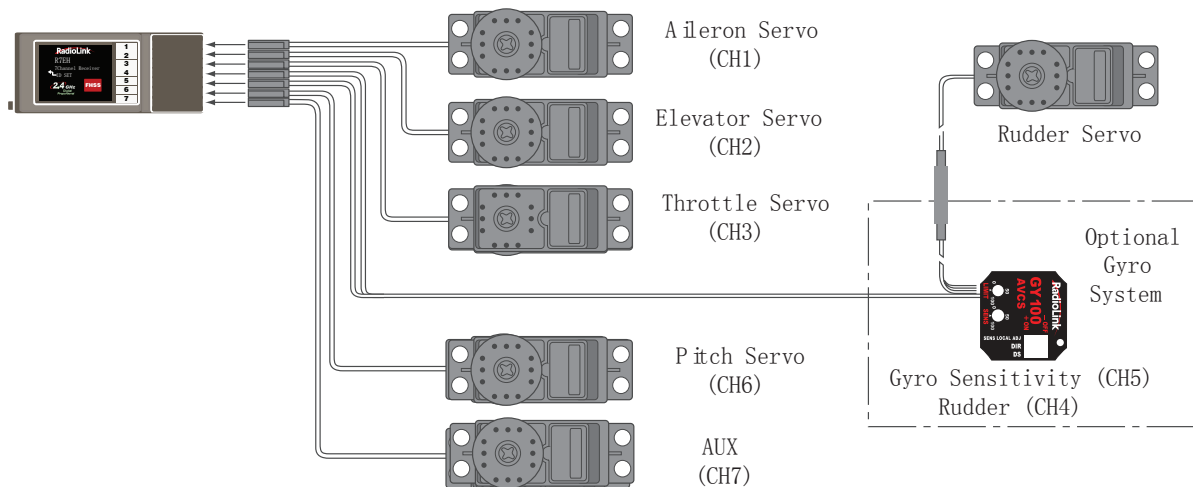

LIQUID CHIP DISPLAY (LCD) & PROGRAMMING CONTROLS

MODE “▲” or “▼” key - Used to scroll through and display the different functions.

SELECT key - Used to scroll the sub-menu for the current function.

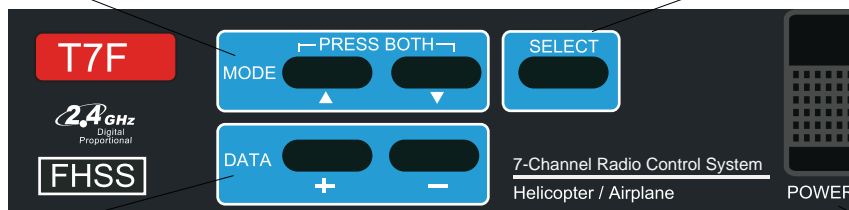

DATA “+” or “-” key - Used to change the values of the various functions displayed on the LCD screen

POWER switch

To open programming menu:

Press MODE “▲” and “▼” keys simultaneously and hold for one second

Press MODE “▲” key to scroll to previous function menu

Press MODE “▼” key to scroll to next function menu

LCD display screen

When the transmitter is initially turned on, the model type, model memory name, and transmitter battery voltage are displayed on the LCD screen. When prompted by the user, the functions and settings stored in the memory can also be read on the screen. The user accesses the different functions using the MODE “▲” or “▼” key and changes the values and settings using the DATA “+” or “-” key. (This is called programming!)

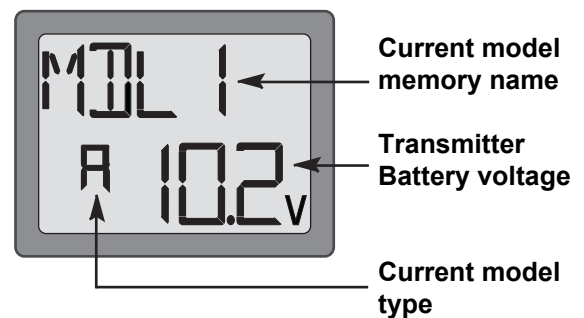

Note: Feel free to explore by scrolling through the programs and viewing the displays using the MODE “▲” or “▼” key. The MODE “▲” or “▼” key only determine what will be displayed on the screen and will not change any of the settings. Only when using the DATA “+” or “-” key will you be able to change any of the settings.

Model name

The Radiolink T7F-2.4GHz stores model memories for six models. This means all the data (control throws, trims, end points, etc.) for up to six different models can be stored in the transmitter and activated at any time (depending upon which model you choose to fly that day). This eliminates the requirement for reconfiguring the transmitter each time you decide to fly a different model with it! When the transmitter is turned on the model type, model name, and the transmitter voltage will be indicated on the LCD screen. Before every flight BE CERTAIN that the correct model name for the model you intend to fly appears on the screen. If the transmitter is not operating the correct model, some (or all) of the controls could be reversed and the travels and trims will be wrong.

Flying a model with the wrong program will result in a crash, so always be certain the model name in the transmitter is correct. One way to ensure this is to write the corresponding model name directly on the airplane or helicopter, or attach a list to the bottom or back of the transmitter.

Transmitter battery voltage

In addition to the model type, the LCD screen also displays the transmitter battery voltage. When the voltage goes below approximately 8.5 Volts the "battery" icon will flash and the lowbattery alarm will continuously beep until the transmitter is turned off. When the low-battery alarm sounds, land immediately your model before losing control.

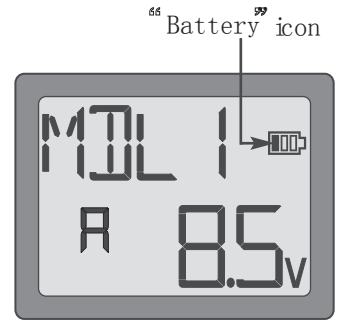

Note: If the transmitter ever reaches 8.9 Volts, land as soon as safely possible. A more reasonable margin of safety would be to quit flying for the day (or recharge the batteries) when the transmitter battery reaches 9.4 Volts.

SUGGESTED GUIDELINES

9.4 Volts - No more flying until recharge.
8.9 Volts - Land as soon as safely possible.
8.5 Volts - **Emergency- Land immediately!**

Mixer alert warning (HELI only)

If the transmitter is turned on with the throttle hold or idle up function switched on, the screen will show "MIX" and a warning will sound. Please turn the throttle hold and idle up functions off to precede.



PROGRAMMING THE T7F-2.4GHz RADIO

Anytime you wish to **view** or **change** any of the current settings in the transmitter, the programming mode must first be entered by, of course, turning on the power, then by pressing the **MODE** “▲” and “▼” keys simultaneously and holding them down for one second. Once in the program the **MODE** “▲” or “▼” key will be used to scroll through each of the functions (**Model type ACRO:** model select/ data reset/ model type select/ model name, reversing, dual rates/ exponentials, end point adjustments, trim, normal throttle curve, programmable mix 1, programmable mix 2, flaperon mixing, flap trim, v-tail mixing, elevon mixing and auxiliary function. **Model type HELI:** model select/ data reset/ model type select/ model name, reversing, dual rates/ exponentials, end point adjustments, trim, normal throttle curve, normal pitch curve, idle-up throttle curve, idle-up pitch curve, throttle hold, revolution mixing, gyro sensitivity, swash-throttle mixing/ swashplate types and auxiliary function.) and the **SELECT** key will be used to scroll the sub-menu for the current function. When a data change is actually required the **DATA** “+” and “-” key will be used to increase or decrease the value of the item displayed, thus making the change.

You can return to the home screen (where the model name and battery voltage is displayed) by pressing the **MODE** “▲” and “▼” keys simultaneously and holding them down for one second.

Note: The functions are listed and described in the order that they appear in the transmitter. Read all the way through the programming instructions before setting up your model (if you won't be using any of the mixing functions for a while you can read those instructions when ready). Refer to the FLOW CHART on page 25(ACRO) or page 26(HELI) as well.

Model Select / Data Reset / Model Type Select / Model Name

MODL Model select function

To select model memory:

1. Access the Model Select function in the programming mode (by pressing the **MODE** “▲” and “▼” keys simultaneously and holding them down for one second). The number for the current, active model will be blinking.
2. To activate a different model memory press the **DATA** “+” or “-” key until the desired model number appears.
3. Now the model has been selected. All programming inputs from this point forward will affect only the model number on the screen (until another model number is selected).

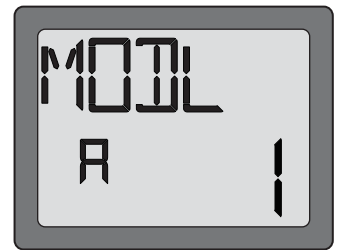

REST Data reset function

All the data for any model memory can be reset to the original factory defaults. Often this function is done to get a “fresh start” and clear the memory before inputting new model settings.

To reset data:

1. Access the Model Select function in the programming mode (by pressing the **MODE** “▲” and “▼” keys simultaneously and holding them down for one second). To select the model memory you wish to reset press the **DATA** “+” or “-” key until the desired model number appears.
2. Once the desired model number is displayed on the screen, press the **SELECT** key twice. A “**REST**” will appear on the screen.
3. Press **DATA** “+” or “-” key for about 2 seconds to clear and reset the memory. “**CLR**” blinks first, and then it stops blinking with a sound. Now the model data is reset to the initial setting that is the default value set at the factory.



The existing modulation and swashplate type settings are not reset. If the power switch is turned off while reset is underway, the data may not be reset.

CAUTION: Resetting the current model memory will permanently erase ALL programming information for that model. The data cannot be recovered (unless you recorded it on a Model Data Recording Sheet in the back of this manual). Do not reset the model unless you are certain you want to clear-out that memory and start from scratch. When actually setting up a model you should have the model in front of you with the power on so you can actually see the effects of your programming inputs and measure the control throws.

ACRO/HELI Model type select function

The Model type select function is used to select the ACRO or HELI mode of model type.

ACRO: Powered aircraft memory type (with multiple wing and tail configurations. See Wing mixing type selection for further information,p16)

HELI: Helicopter memory type (with two helicopter swashplate type. See Swashplate types selection for further information,p23)

CAUTION: Before doing anything else to set up your aircraft, first you must decide Model type (include wing mixing type or swashplate type) best fits this particular aircraft.

To select model type:

1.Access the Model Select function in the programming mode (by pressing the MODE“▲”and“▼” keys simultaneously and holding them down for one second). To select the model memory, select model type, press the DATA “+” or “-” key until the desired model number appears.

2.Press SELECT key after seeing on the screen the model memory where you want to select model type. Then you will see “ACRO” and “HL” or “HELI” and “AC” on the screen.

3.To change model type, press the DATA “+” or “-” key and hold it down for about two seconds. “HL” and “AC” blinks first, and then it stops blinking with a sound. The current model type “ACRO” or “HELI” is displayed.



Model name function

Assign a name to the model memory. By giving each model a name that is immediately recognizable, you can quickly select the correct model, and minimize the chance of flying wrong model memory that could lead to a crash.

To assign a name

1.Access the Model Select function in the programming mode (by pressing the MODE“▲”and“▼” keys simultaneously and holding them down for one second). To select the model number you wish to change, press the DATA “+” or “-” key until the desired model number appears..

2.Press SELECT key three times after seeing on the screen the model memory where you want to set the model name. Then you will see the model name on the screen.

3.Choose a character for the first digit by using DATA “+” or “-” key. Then move to the next digit by pressing the SELECT key and choose a character in the same way. Continue choosing characters for the third and fourth digits. You can use up to four characters for the name.

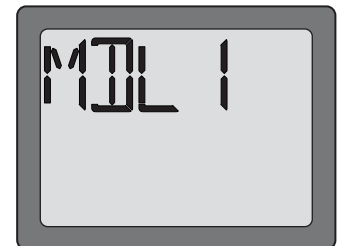

REVR Servo Reversing

The servo reversing function is used to change the direction that a servo responds to a control input from the transmitter (stick or switch). After using the reversing function, check all the controls on the model to be certain they are operating in the correct direction and that you did not inadvertently reverse a servo other than the one intended. Reversing the wrong servo (and not checking the response of the controls before each flight) may be the most common cause of a crash!

To reverse a servo:

1.Enter the programming mode and use the MODE“▲”or“▼” key to access the **REVR** function.

2.Use the SELECT key to select the channel you wish to reverse.

3.Press the DATA “-” key to reverse the servo (REV), or press the DATA “+” key to make the servo operate normally (NOR). The arrow will indicate the condition of the servo (normal or reversed).

4.Use the SELECT key to display other channels to be reversed

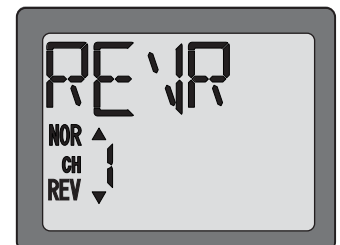

Dual Rates / Exponential Settings

The aileron, elevator and rudder dual rates on the T7F are simultaneously activated by the dual rate switch. The amount of travel decrease for each control may be set between 0% and 100% of the values set for the end points.(explained in End Point Adjustment on page 13).

Note: It is possible to set a dual rate value to zero, thus causing no response from that channel. If the dual rates are inadvertently set to zero, a crash could result.

Note: When performing initial model setup, the E.P.A.s should be set prior to setting the dual rates. When setting the E.P.A.s for the first time on a new model, the dual rates should be set to 100%.

D/R Dual Rate Settings

To set the dual rates:

1. Enter the programming mode. Access the "D/R" screen with the MODE "▲" or "▼" key.
2. Select the channel to be adjusted (1-aileron, 2-elevator, 4-rudder) by pressing the SELECT key until the desired channel number appears on the left side on the screen. Note: If an "EXPO" appears on the screen, you have pressed the SELECT key too many times and displayed the values for the exponentials (explained later). Press the SELECT key to return to the dual rate values.
3. Place the dual rate switch in the desired position for the value you wish to change. (Generally, pilots prefer to have the switch in the "up" position for the high rate, and in the "down" position for the low rate.)
4. Change the dual rate value using the DATA "+" or "-" key until the desired control throw is achieved. If you wish to change the control throw when the switch is in the other position as well, flip the switch, then use the DATA "+" or "-" key to change the throw.
5. Repeat the procedure for the other dual rate (channel 2-elevator, 4-rudder).

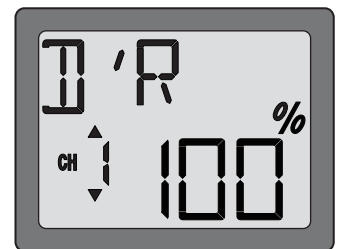

EXPO Exponential Settings

The "exponentials" are in the same function as the dual rates. (Pressing the MODE "▼" key will take you to the next function which is End Point Adjustments). The same as dual rates, "expos" can be set for both switch positions. Negative exponential (-) decreases initial servo movement. Positive exponential (+) increases initial servo movement. The exponential "curve" may be set anywhere between -100% and +100%.

To set the exponentials:

1. Enter the programming mode. Access the "D/R" screen with the MODE "▲" or "▼" key.
2. Access the "EXPO" screen with the SELECT key.
3. Select the channel (1-aileron, 2-elevator, 4-rudder) you wish to set by pressing the SELECT key. The active channel number will be displayed on the screen. Note: If a "D/R" appears on the screen, you have pressed the SELECT key too many times and displayed the values for the D/R (dual rate values). Press the SELECT key to return to the exponentials.
4. Position the dual rate switch where desired for the value you wish to change.
5. Enter the amount of exponential with the DATA "+" or "-" key. (As stated above, an exponential value with a "-" in front of it makes the initial servo movement less, or "softer.")
6. Flip the switch to the other position to enter the exponential value for that switch position.
7. Repeat for the settings on the other channel.

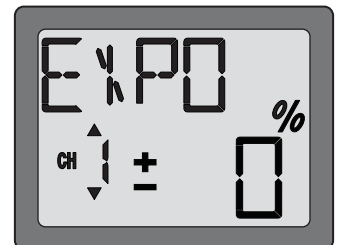

EPA End Point Adjustment

Note: Since changing the "end points" will also change the dual rates, the end points should be set prior to setting the dual rates. If you set the dual rates first, and then go back and change the end points, the dual rate throws will also change.

The EPA function is designed to “fine tune” the servo throws in cases where changing the pushrod hookup will not achieve the correct throw. The pushrods should first be connected to the servo arms and control horns so that the correct, or near correct control surface throw will be achieved. THEN the EPAs may be used to make small changes in the servo throw until the desired control throw is achieved. The control throws should be set up so that the “end points” are as near to 100% as possible. If the EPA values must be set below 70% or above 120% to get the desired throw, you should strongly consider changing the pushrod connections so the values can be set closer to 100%. (When the EPA is set to 100% the maximum servo throw for channels 1, 2, 3 & 4 is approximately 40° and approximately 55° for channels 5 & 6.)

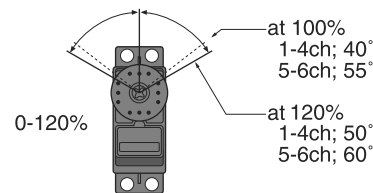

To set the end points:

1. Enter the programming mode and use the MODE “▲” or “▼” key to access the “EPA” screen. The channel number being adjusted will appear on the left side on the screen and the “%” symbol will be flashing.
2. To change the RIGHT aileron throw move the aileron stick to the right, then press the DATA “+” or “-” key to change the value and the throw.
3. Move the stick to the left and use the DATA “+” or “-” key to change the LEFT aileron throw.
4. Use the SELECT key to display the other channels and set the other end points. Notice that moving the stick (or switch) from one end to the other changes the value displayed and the position of the arrow for that “end” of the control input.

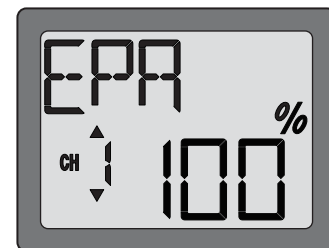

TRIM Trim Settings

There are four trim levers (“trims”) on the front of the transmitter. Three of the trims are for adjusting the neutral position of the aileron, elevator and rudder servos. The fourth trim is for setting the idle r.p.m. of the engine when the throttle stick is all the way down. The intended use of the trims is to make small servo adjustments, in flight, to get the model properly “trimmed” (so it will fly straight-and-level). Because the trims are intended to be used while the model is in flight, you do not have to “enter the program” to adjust the trims. Simply push or pull on the trim levers while flying and the neutral position of the servos will shift. Keep in mind that you should start out with the control surfaces centered when the servos are centered and the trims are “zeroed” (or near zero). THEN you can adjust the trims once airborne.

Center the servos:

1. Turn on the transmitter and receiver. Operate the controls to make sure the servos respond in the correct direction. Use the reversing function to reverse any servos necessary.
2. Center the throttle control stick.
3. Place the servo arms on the servos so they are perpendicular to the pushrods (see page 6) . It is okay to cut off any unused servo arms.
4. Connect the pushrods to the control surfaces. Adjust the length of the pushrods until the control surfaces are centered when the servos are centered.

Note: The throttle trim affects the throttle servo only when the throttle stick is below “1/2 stick.” This way, the final closing of the carburetor can be adjusted without affecting the servo throughout the rest of the range.

To adjust the trim settings:

Once the servos and control surfaces have been connected and the control throws have been set using the end points and dual rates, get the model airborne. Adjust the trims as necessary to get the model to fly straight-and-level. If much trim is required on any one control it is a good idea to readjust the pushrods so the trims can be returned to neutral (zero). Adjusting the trims with the trim levers changes the servo’s position in increments of “4.” If finer adjustments are required, land the model, then enter the program as described below to adjust the trims in increments of “1.”

1. Enter the programming mode and use the MODE “▲” or “▼” key to activate the TRIM menu.
2. Press the SELECT key to display the channel to be adjusted (the figure shows trim adjustment for CH1).
3. Adjust the trim using the DATA “+” or “-” key. Note that initially, the values change in increments of “1,” but if the DATA “+” or “-” key is held long enough the values will change more rapidly.
4. Repeat the steps for other channels that require trim adjustments

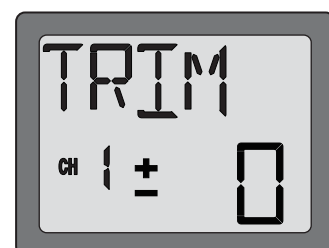

N-TH Normal throttle curve function(ACRO)

Used to set throttle curve for normal flight. 5-point throttle curve can be adjusted from 0-100% each point. This function is used to coordinate 1,2,4 channel to achieve some aerobatics, or to adjust the relative angular position between the amount of throttle and the throttle control stick.

The starting point of different kinds of the motor and ESC can also be adjusted by “N-TH” curve function.

To set the normal throttle curve:

1. Enter the programming mode and use the MODE“▲”or“▼” key to access the “N-TH” function. Throttle stick position number will appear on left side of display and “%” symbol will be flashing.
2. Use SELECT key to select the desire curve point. Point 1 is shown initially which is throttle stick all the way downward (slow) position. Point 5 is throttle stick all the way upward (hi) position.
3. Press DATA “+” or “-” key to set the servo position.
4. Use SELECT key to set other points in same manner.

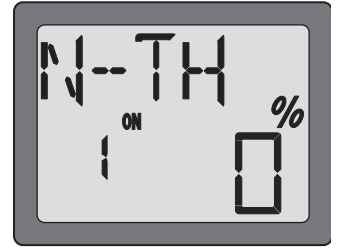

PMIX1/2 Programmable Mixer 1/2 (ACRO only)

Unlike the “wing mixing” function (explained later) where the channels to be mixed are factory-set, the T7F-2.4GHz also contains two programmable mix where you, the pilot determine the channels to be mixed. This could be used to correct unwanted flight tendencies (by mixing rudder to aileron, or aileron to rudder for example).

To set up a programmable mix:

1. Enter the programming mode. Access the “PMIX” screen with the MODE“▲”or“▼” key.

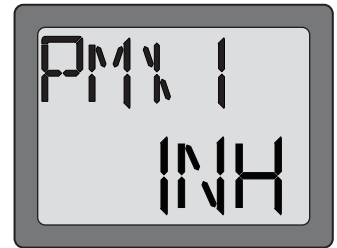

2. Press the DATA “+” key. This will cause the flashing “INH” display to change to a flashing “ON” display.

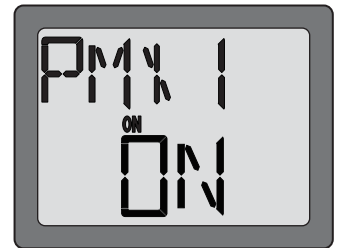

3. Press SELECT key twice to call the screen for selecting channels to control “MAS” (Master) mixing. Then select the channel by pushing DATA “+” or “-” key . Channel 1 (aileron) in this figure is assigned to the master.

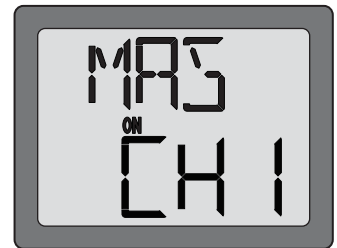

4. Press SELECT key three times to call the screen for selecting channels to control “SLV” (Slave) mixing. Then select the channel by pushing DATA “+” or “-” key. Channel 4 (rudder) in this figure is assigned to the slave.

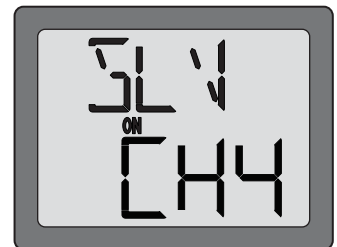

5. Press the SELECT key once to display the flashing % sign. Use the DATA “+” key to set the percentage of mixing from -100% to +100% (depending on the direction and distance you wish the slave servo to move).

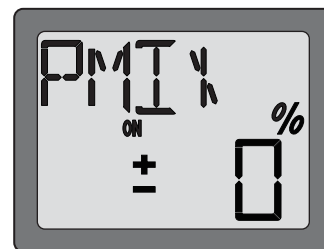

6. Press SELECT key four times to call the screen for selecting the on/off switch. Then select the switch by pushing DATA “+” or “-” key. CH5, D/R, or FLP switch (include the on direction) is selectable. The “ON” is “always on”.

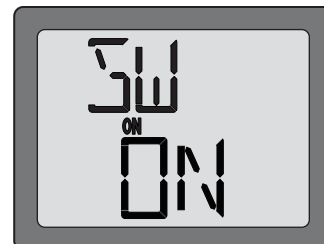

7. Observe how the controls on the model respond to be certain you have achieved the correct mix and that the throws are as desired.

Wing Mixing Type Selection (ACRO only)

With the programmable mix (previously described) the user determines the two channels to be mixed. The wing mixing function is another mix that may be used, but the channels mixed are predetermined. There are three different wing mixing functions to select from:

FLPR Flaperon mixing (ACRO only)

This function allows the ailerons to be used both as ailerons and as flaps. The flap control switch (CH 6) operates the flap function. To use flaperon mixing both ailerons must be operated by separate servos.

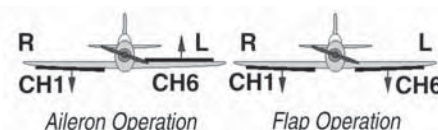

*If necessary, use the Servo Reversing function to achieve the correct direction of servo throws.

To activate flaperon mixing:

1. Connect the aileron servo in the right wing to channel 1 (aileron) in the receiver and connect the aileron servo in the left wing to channel 6 (flaps) in the receiver.
2. Enter the programming mode. Access the “FLPR” screen with the MODE “▲” or “▼” key.

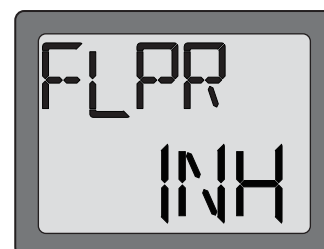

You cannot set “Flaperon” mixing when “Elevon” mixing has already been set. In order to enable “Flaperon” mixing, you first need to cancel “Elevon” mixing. However, it is allowed to use “Flaperon” and “V-Tail” mixing simultaneously.



3. Press the DATA “+” key. This will cause the flashing “INH” display to change to a flashing “ON” display. Now the mixing is on.



4. If you need to set aileron differential, press the SELECT key to display the flashing “%” sign. Use the DATA “+” key to set the percentage of aileron differential from -100% to +100% (The “-” direction indicates decreasing amount of movement toward the upward from the aileron surface, while “+” direction indicates decreasing amount of movement toward the downward from the aileron surface.)

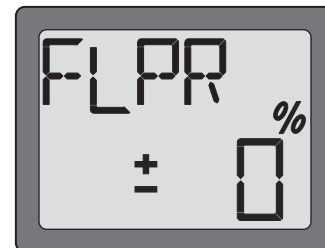

5. Once this mix has been activated, move the servos to their full extremes to make certain they are not overdriving the controls. If necessary, adjust the linkages to achieve the correct control throws.

FLTR Flap trim (ACRO only)

The Flap Trim function is used to specify the amount of flap travel produced moving the flap switch. Use of the normal flap switch will be inhibited if the flaperon function is activated, so the Flap Trim function should be activated if you need to control flaps by the Flap switch.

To activate flap trim:

1. Enter the programming mode. Access the “FLTR” screen with the MODE “▲” or “▼” key.



2. If “INH” is blinking, press DATA “+” key. Then you will see that the blinking “INH” changes to “ON”. Your flap trim is now turned on.



3. Set the travel of the flap switch at between -100% and +100% by using DATA “+” or “-” key. Two rates (upward and downward of flap switch) are adjustable.

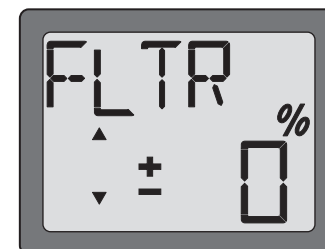

V-TL V-tail mixing (ACRO only)

Intended for V-tail aircraft (such as a Beechcraft Bonanza), V-tail mixing allows the ruddervators to operate both as rudders and elevators. The same as the other mixes, V -tail mixing requires that each ruddervator be operated by a separate servo.

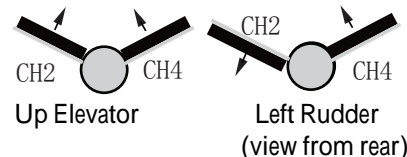

*If necessary, use the Servo Reversing function to achieve the correct direction of servo throws.

To activate V-tail mixing:

1. Connect the left ruddervator servo to channel 2 (elevator) in the receiver and connect the right ruddervator servo to channel 4 (rudder) in the receiver.
2. Enter the programming mode. Access the "V-TL" screen with the MODE "▲" or "▼" key.

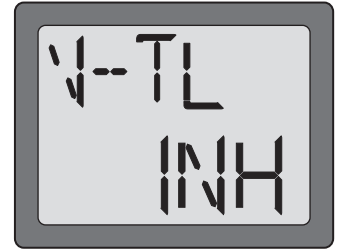

You cannot set "V-tail" mixing when "Elevon" mixing has already been set. In order to enable "V-tail" mixing, you first need to cancel "Elevon" mixing. However, it is allowed to use "V-Tail" and "Flaperon" mixing simultaneously.

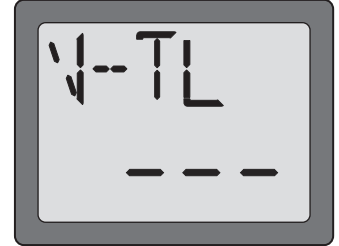

3. Press the DATA "+" key. This will cause the flashing "INH" display to change to a flashing "ON" display. Now the mixing is on.

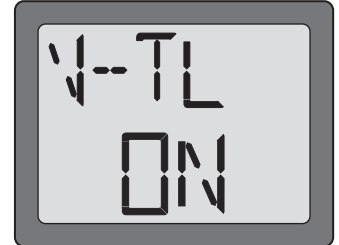

4. Next you may set the elevator. Press the SELECT key to display the "CH2" and flashing "%" sign. Use the DATA "+" key to set the percentage of elevator travel rate from -100% to +100%

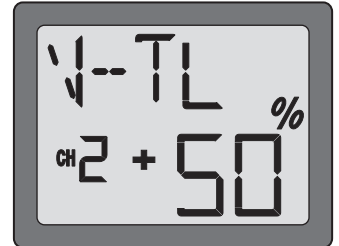

5. Next you may set the rudder. Press the SELECT key to display the "CH4" and flashing "%" sign. Use the DATA "+" key to set the percentage of rudder travel rate from -100% to +100%

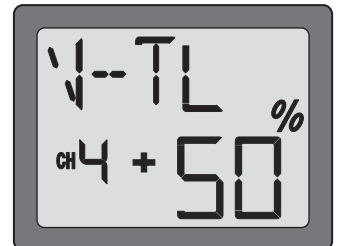

6. Once this mix has been activated, move the servos to their full extremes to make certain they are not overdriving the controls. If necessary, adjust the linkages to achieve the correct control throws.

*If necessary, use the Servo Reversing function to achieve the correct direction of servo throws.

ELVN Elevon mixing (ACRO only)

Intended for tailless, "flying wing" models such as delta wings and flying wings, elevon mixing mixes channel 1 (aileron) to channel 2 (elevator) allowing the elevons to operate in unison (as elevators) or in opposition (as ailerons). This function requires that each elevon be operated by a separate servo.

To activate elevon mixing:

1. Connect the servo in the right wing to channel 2 (elevator) in the receiver and connect the servo in the left wing to channel 1 (aileron) in the receiver.

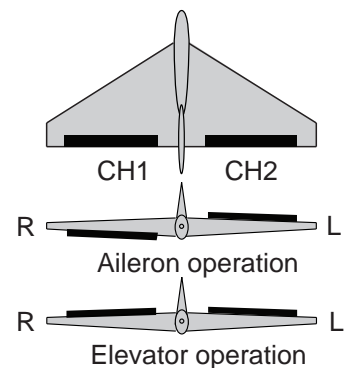

2. Enter the programming mode. Access the “ELVN” screen with the MODE“▲”or“▼” key.

You cannot set “Elevon” mixing when “Flaperon” or “V-TL” mixing has already been set. In order to enable “Elevon” mixing, you first need to cancel both “Flaperon” and “V-tail” mixing.

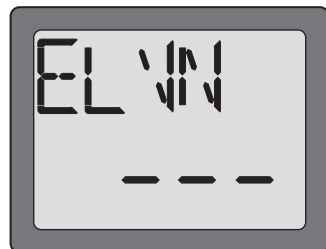
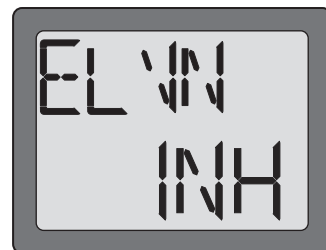

3. Press the DATA“+” key. This will cause the flashing “INH” display to change to a flashing “ON” display. Now the mixing is on.



4. Next you set the left wing to channel 1 (aileron) setting. Press the SELECT key to display the “CH1” and flashing “%” sign. Use the DATA “+” key to set the percentage of elevator travel rate from -100% to +100%

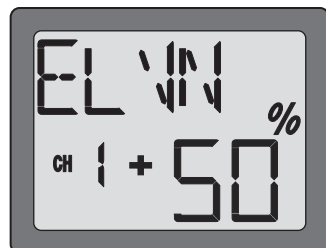

5. Next you set the right wing to channel 2 (elevator) setting. Press the SELECT key to display the “CH2” and flashing “%” sign. Use the DATA “+” key to set the percentage of rudder travel rate from -100% to +100%

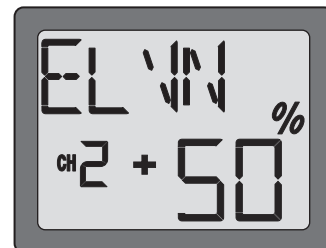

6. Once this mix has been activated, move the servos to their full extremes to make certain they are not overdriving the controls. If necessary, adjust the linkages to achieve the correct control throws.

AUX 7-channel(CH7) auxiliary function

The 7-channel(CH7) is a switch used for auxiliary function, such as open or close a dropping cabin, switch on or switch off the control panel of smoke releasing etc.

To set up AUX:

Enter the programming mode. Access the “AUX” screen with the MODE“▲”or“▼” key.

Press MODE“▲” key can access directly.

1. The 7-channel(CH7) switch push up.

The percentage value can be set from +100% to -100% by pressing DATA “-” key, and the arm of servo moves from 0° to 60° proportionally.

2. The 7-channel(CH7) switch push down.

The percentage value can be set from -100% to +100% by pressing DATA “+” key, and the arm of servo moves from 60° to 0° proportionally.

3. Push up the 7-channel(CH7) switch and set the percentage value to be -100%, then push down the 7-channel(CH7) switch and set the percentage value to be +100%, the direction that a servo responds to a control input from the transmitter (stick or switch) would be reversed.

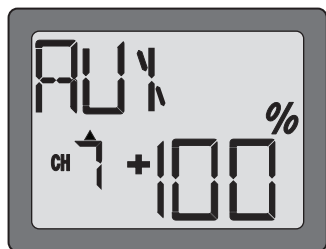

N-TH Normal throttle curve function (HELI only)

Used to set throttle curve for normal flight. 5-point throttle curve is utilized to best match the blade collective pitch to the engine RPM for consistent load on the engine. Throttle curve can be adjusted from 0-100% each point. This normal throttle curve creates a basic curve for hovering. Use this function together with the normal pitch curve (see Normal pitch curve) so that up/down control has a constant engine speed.

To set the normal throttle curve:

1. Enter the programming mode and use the MODE “▲” or “▼” key to access the “N-TH” function. Throttle stick position number will appear on left side of display and “%” symbol will be flashing.
2. Use SELECT key to select the desired curve point. Point 1 is shown initially which is throttle stick all the way downward (slow) position. Point 5 is throttle stick all the way upward (hi) position.
3. Press DATA “+” or “-” key to set the servo position.
4. Use SELECT key to set other points in same manner.

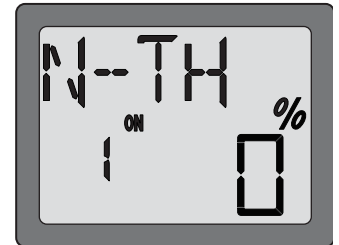

N-PI Normal pitch curve function (HELI only)

Used to set pitch curve for normal flight. 5-point pitch curve is utilized to best match the blade collective pitch to the engine RPM for consistent load on the engine. Pitch curve can be adjusted from 0-100% each point. This normal pitch curve creates a basic curve for hovering. Use this function together with the normal throttle curve so that up/down control has a constant engine speed.

To set the normal pitch curve:

1. Enter the programming mode and use the MODE “▲” or “▼” key to access the “N-PI” function. Throttle stick position number will appear on left side of the display and “%” symbol will be flashing.
2. Use SELECT key to select the desired curve point. Point 1 is shown initially, which is throttle stick all the way downward (slow) position. Point 5 is throttle stick all the way upward (hi) position.
3. Press DATA “+” or “-” key to set the servo position.
4. Use SELECT key to set other points with same manner.

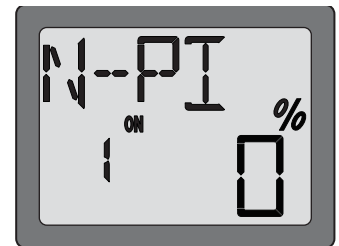

I-TH Idle-up throttle curve function (HELI only)

Used to set throttle curve for idle up flight. 5-point throttle curve is utilized to best match the blade collective pitch to the engine RPM for consistent load on the engine when idle up function is on. Throttle curve can be adjusted from 0-100% each point. This idle up throttle curve is to set consistent engine RPM and can be activated at any time when mid air maneuvers are executed, such as loops, rolls, and 3D flight, even when the blade collective pitch is reduced.

To set the idle-up throttle curve:

1. Enter the programming mode and use the MODE “▲” or “▼” key to access the “I-TH” function.

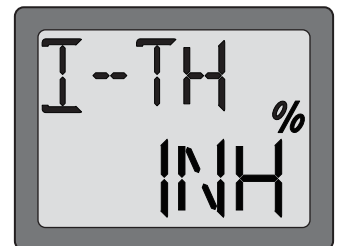

2. Press the DATA “+” key. This will cause the flashing “INH” display to change to a flashing “ON” display. Now the I-TH function is on. Press the SELECT key, and throttle stick position number appears on left side of display and “%” blinks.

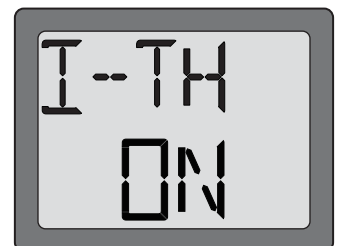

- Use SELECT key to select the desired curve point. Point 1 is shown initially, which is the throttle stick's all the way downward (slow) position. Point 5 is the throttle stick's all the way upward (hi) position.
- Press DATA "+" or "-" key to set the servo position.
- Use SELECT key to set other points in same manner.

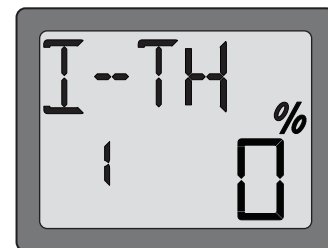

I-PI Idle-up pitch curve function: (HELI only)

Used to set pitch curve for idle up flight. 5-point pitch curve is utilized to best match the blade collective pitch to the consistent engine RPM when idle up is used. Pitch curve can be adjust from 0-100% each point. The high side pitch curve should be set to not overload the engine and keep consistent engine RPM. Generally, set less pitch than normal maximum pitch. The low side pitch curve should be set for desired maneuvers such as loops, rolls, and 3D flight.

To set the idle-up pitch curve:

- Enter the programming mode and use the MODE "▲" or "▼" key to access the "I-PI" function.
- This is the idle up pitch curve, to use this function the "I-TH" Idleup throttle function must be activated first.

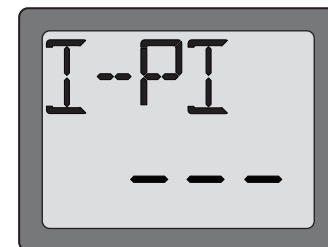

- Use SELECT key to select the desired curve point. Point 1 is shown initially, which is the throttle stick's all the way downward (slow) position. Point 5 is the throttle stick's all the way upward (hi) position.
- Press DATA "+" or "-" key to set the servo position.
- Use SELECT key to set other points in same manner.

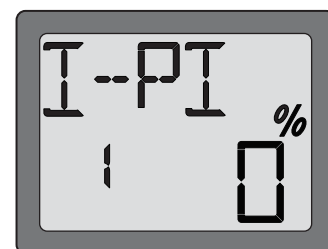

HOLD Throttle hold function (HELI only)

Throttle hold function is to be used for autorotations where only pitch control is used to make a descent and landing. Just flip the hold switch on to set the engine in the idling or cut position and disengage it from the Throttle Stick. It can be set from (-)50 to (+)50% from throttle trim position.

To set the throttle hold:

- Enter the programming mode and use the MODE "▲" or "▼" key to access the "HOLD" function.
- Press the DATA "+" key. This will cause the flashing "INH" display to change to a flashing "ON" display. Now the "HOLD" function is on.
- Push SELECT key once. This will cause the flashing "%" symbol on the display. Pull the hold switch towards you. Press DATA "+" or "-" key to set the throttle servo position of throttle hold.

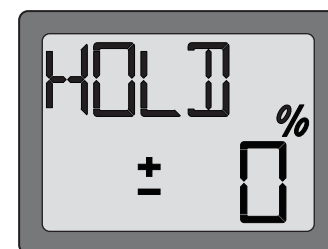
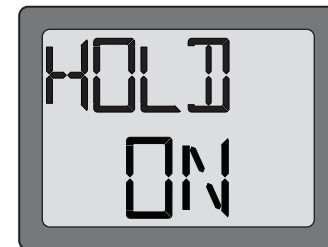
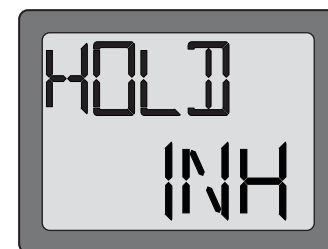

REVO Pitch-rudder mixing function (HELI only)

This mix adds rudder in conjunction with pitch. This helps compensate for rotation of the helicopter caused by the increased engine torque. (Never use revo. mixing with a heading-hold/AVCS gyro which is in heading hold/AVCS mode. However, revo. mixing is still used when a heading-hold/AVCS gyro is in normal mode.)

To set the REVO mixing:

1. Enter the programming mode and use the MODE “▲” or “▼” key to access the “REVO” function.

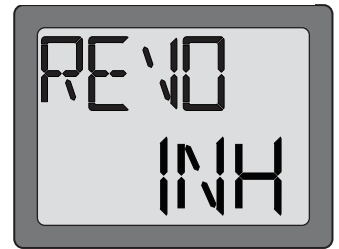

2. Press the DATA “+” key. This will cause the flashing “INH” display to change to a flashing “ON” display. Now the “REVO” function is on.

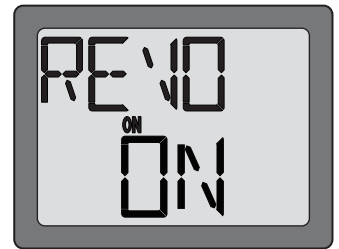

3. Press the SELECT key once. This will cause the flashing “%” symbol on the display. It can set mixing amount on throttle stick hi side and low side separately. When you move the throttle stick to the low side from neutral, the arrow indicates down direction. Then press DATA “+” or “-” key to set the mixing amount of the low side. When you move the throttle stick to the high side from neutral, the arrow indicates up direction. Then press DATA “+” or “-” key to set the mixing amount of the hi side.

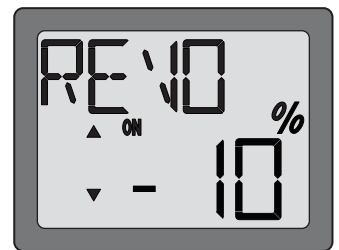

GYRO Gyro mixing function (HELI only)

GYROS : Using electronics to take some of the complexity out of setups and flight. What is a gyro? A gyroscope is an electronic unit that senses rotational movement and corrects for it. For example, if the wind blows your helicopter's tail to the left, a gyro will sense that motion (and confirm that no input was given) and will correct for it.

How does it help in helicopter setup? A good gyro will totally eliminate the need for revo. mixing. The gyro will sense and correct the unwanted motion for you, so you don't have to spend time to get a complex curve operating properly.

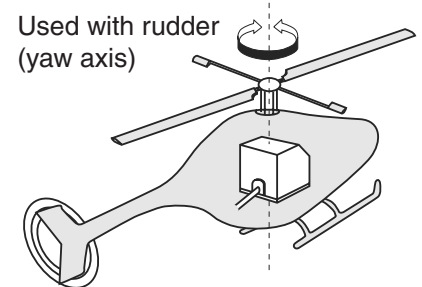

Gyro sensor kinds: There are many different kinds of gyros. Early gyros were mechanical, with a spinning drum similar to a child's gyroscope toy. The next generation utilized a special type of crystal, called piezoelectric, which sensed the motion and provided an electrical pulse. The finest gyros at the time of this writing are SMM technology. These silicone micro machines, or computer chips, sense the motion. SMM is far more accurate and less susceptible to inaccuracies caused by temperature changes, etc.

Choosing the right gyro for your skills, your helicopter, and your budget:

Mechanical: some are still available. They are very challenging to set up and not as reliable as piezo or SMM.

Non-Heading-Hold Piezo: these are now inexpensive gyros that are reliable and easy to set up. Some have dual rates and remote gain control to adjust sensitivity in flight. Lack heading-hold capabilities for precision flying.

Heading-Hold Piezo: Until recently, the cream of the crop. Expensive, and more complex to set up. Adds GPS-like heading recognition. Exhibits minor difficulties with temperature drift (position setting varying with unit's temperature).

Heading-Hold SMM: 21st Century gyro technology. Computer chip technology. Expensive, easier set up, higher durability. Significant decrease in temperature sensitivity. Many include frame rate settings to allow faster response when using

specialized digital servos. Examples:

RadioLink GY-100: Simpler set up. Ideal for learning aerobatics through 3D

Gyro mixing function is used for adjusting the gain of the gyro. Select from two different gain settings using a switch on the transmitter.

To set the GYRO mixing:

1. Plug the gyro's sensitivity adjustment to channel 5 of the receiver. (not assignable)
2. EPA of channel 5 to set 100% both UP and DOWN.
3. Enter the programming mode and use the MODE "▲" or "▼" key to access the "GYRO" function.
4. Press the DATA "+" key. This will cause the flashing "INH" display to change to a flashing "ON" display. Now the mixing is on.
5. Press the SELECT key once. This will show the gyro gain setting and flashing "%" symbol on the display.

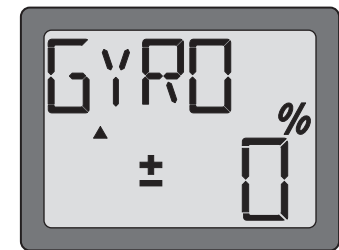

Flip the gyro (CH5) switch up and down. This will cause the arrow on the display to point up and down corresponding to the switch position. Press DATA "+" or "-" key to set the gyro gains for both switch up and down position. Gyro gain can be adjust from -100% to +100%

Example of sensitivity setting with **RadioLink GY-100**

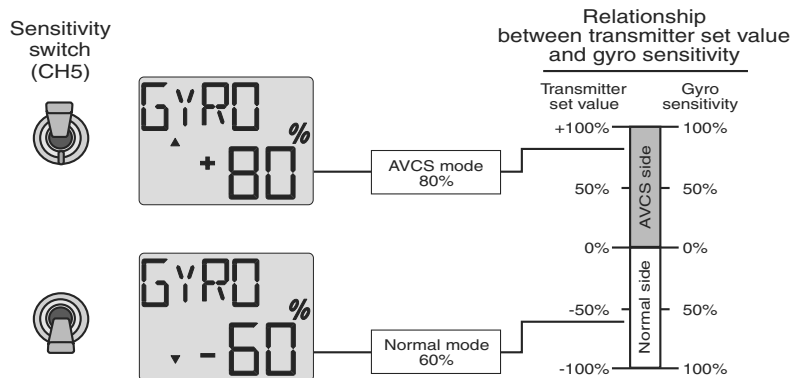

SWSH Swashplate types selection & Swash AFR (HELI only)

This function can select from two swashplate types. Swash AFR can be set, if you choose 3-S type

1-S: Independent aileron, pitch and elevator servos linked to the swashplate. Most kits are 1-S type.

3-S: With Aileron inputs, the aileron and pitch servos tilt the swashplate left and right; with Elevator inputs, the three servos tilt the swashplate fore and aft; with Pitch inputs, all three servos raise the swashplate up and down.

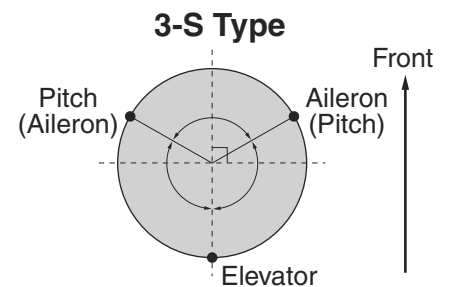

To select the swashplate types:

1. Enter the programming mode and use the MODE“▲”or“▼” key to access the “**SWSH**” function.
2. To select swashplate type press the DATA “+” or “-” key for about two seconds. When you are changing swashplate type to 1-S or 3-S, the 1-S or 3-S on the display flashes slow, becomes rapid, and then returns slow flashing with confirmation sound.
3. Now set the swashplate type.

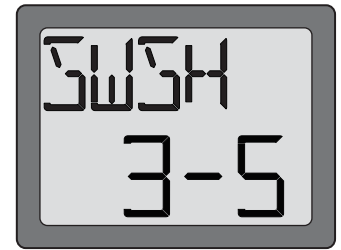

To set the swash AFR:

This function can be used only when you select the 3-S swashplate type. There is no swash AFR setting with 1-S type. This swash AFR function is for changing the direction and amount of servo movement on aileron, elevator, and pitch.

At first, set the linkage and servo horn length on aileron, elevator, and pitch servos by following the instruction manual that comes with the model. Basically “EPA” (see page 13) is set near 100% with these three servos. Set the servo “reverse” function (see page 12) so that the swashplate keeps horizontal and moves in the correct direction up and down when you operate pitch control (up and down throttle stick).

1. Enter the programming mode and use the MODE“▲”or“▼” key to access the “**SWSH**” function.

2. Swashplate types, Confirm 3-S type is selected. If 3-S type is not selected, please see “**To select the swashplate types**” and set.

3. Use SELECT key to select the channel you wanted to set. Aileron channel “**CHA**” is displayed at first and “%” is flashing. Move the aileron stick left and right to set the direction and amount of movement on the aileron servo by pressing DATA “+” or “-” key. Aileron movement can be adjusted from -100% to +100% .

4. Select other channels (elevator and pitch) by SELECT key to set the direction and amount of servo movement in same manner as aileron channel setting. “**CHE**” is elevator and “**CHP**” is pitch channel on the Display.

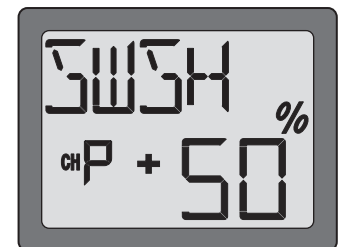
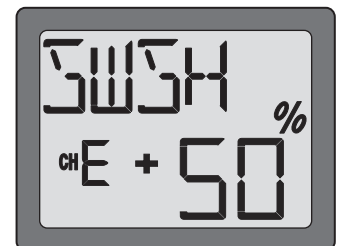
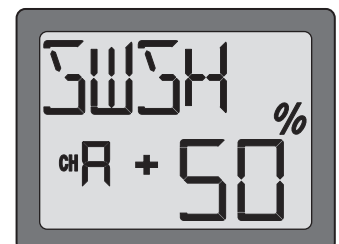

AUX 7-channel(CH7) auxiliary function

The 7-channel(CH7) is a switch used for auxiliary function, such as open or close a dropping cabin, switch on or switch off the control panel of smoke releasing etc.

To set up AUX:

Enter the programming mode. Access the “**AUX**” screen with the MODE“▲”or“▼” key. Press MODE“▲” key can access directly.

1. The 7-channel(CH7) switch push up.

The percentage value can be set from +100% to -100% by pressing DATA “-” key, and the arm of servo moves from 0° to 60° proportionally.

2. The 7-channel(CH7) switch push down.

The percentage value can be set from -100% to +100% by pressing DATA “+” key, and the arm of servo moves from 60° to 0° proportionally.

3. Push up the 7-channel(CH7) switch and set the percentage value to be -100%, then push down the 7-channel(CH7) switch and set the percentage value to be +100%, the direction that a servo responds to a control input from the transmitter (stick or switch) would be reversed.

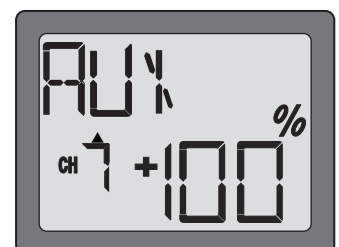

FLOW CHART ACRO MODE FUNCTIONS

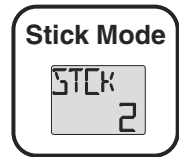
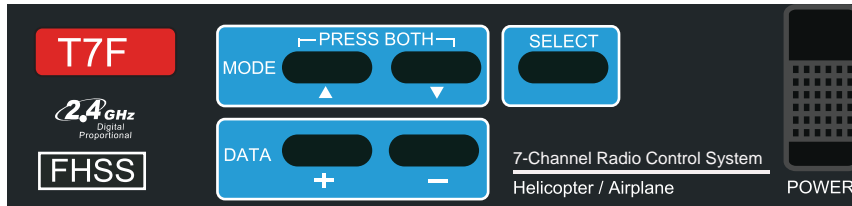

To enter or leave Programming Mode, press MODE “▲” and “▼” keys simultaneously for one second.

(Press MODE “▲” and “▼” keys simultaneously for one second)

Press MODE “▲” key to scroll to previous function menu.
Press MODE “▼” key to scroll to next function menu.

To change the Stick Mode, hold the MODE “▲” and “▼” keys down simultaneously, then turn on the transmitter.
Use the DATA “+” or “-” key to display the desired stick mode.

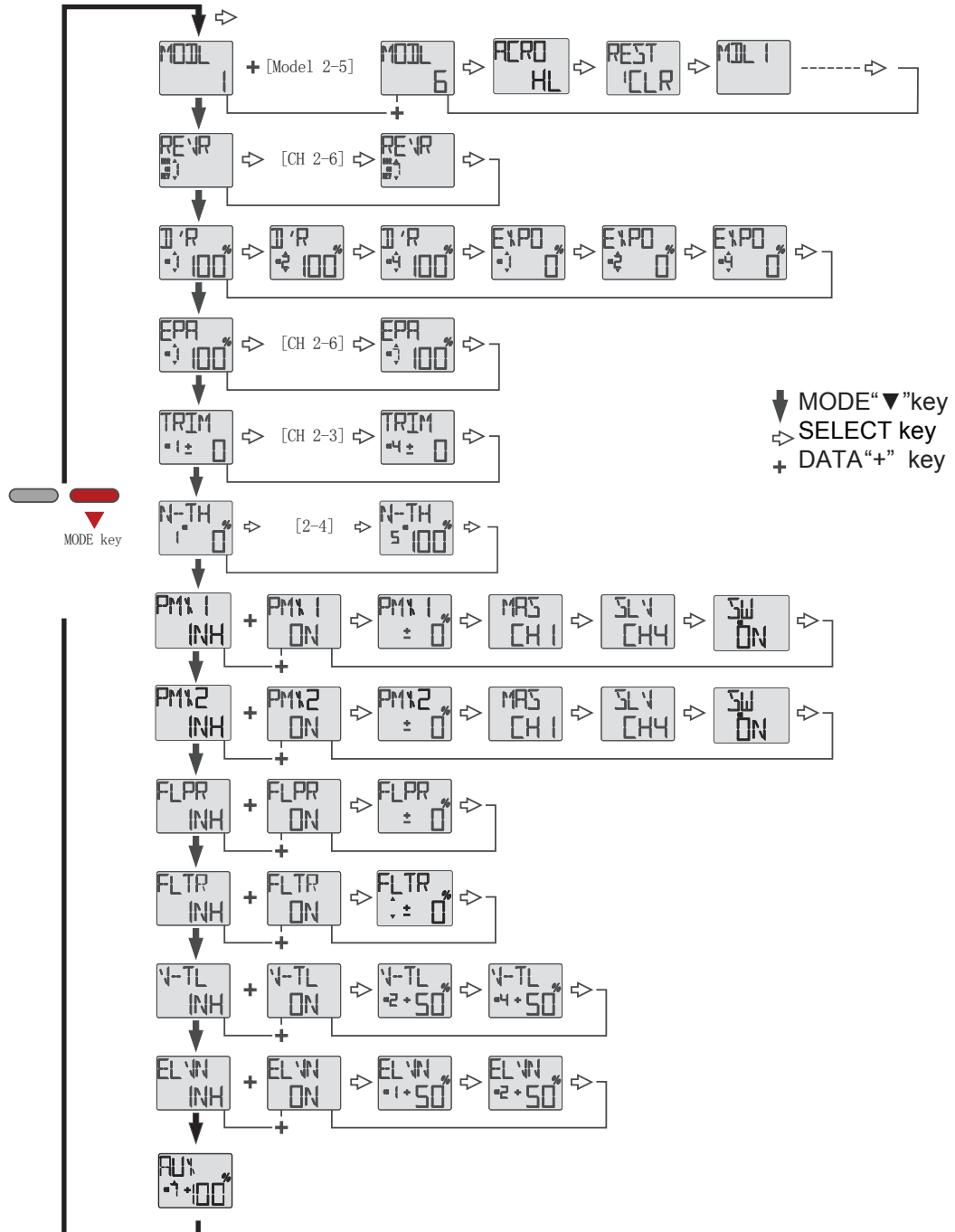

Simultaneously press the MODE “▲” and “▼” keys and hold them down for one second to enter the programming mode. Press the keys again (or turn off the transmitter) to exit the programming mode.

FLOW CHART HELI MODE FUNCTIONS

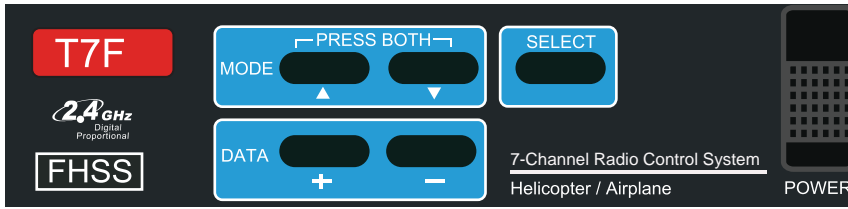

To enter or leave Programming Mode, press MODE “▲” and “▼” keys simultaneously for one second.

Press MODE “▲” key to scroll to previous function menu.
Press MODE “▼” key to scroll to next function menu.

To change the Stick Mode, hold the MODE “▲” and “▼” keys down simultaneously, then turn on the transmitter. Use the DATA “+” or “-” key to display the desired stick mode.

(Press MODE “▲” and “▼” keys simultaneously for one second)

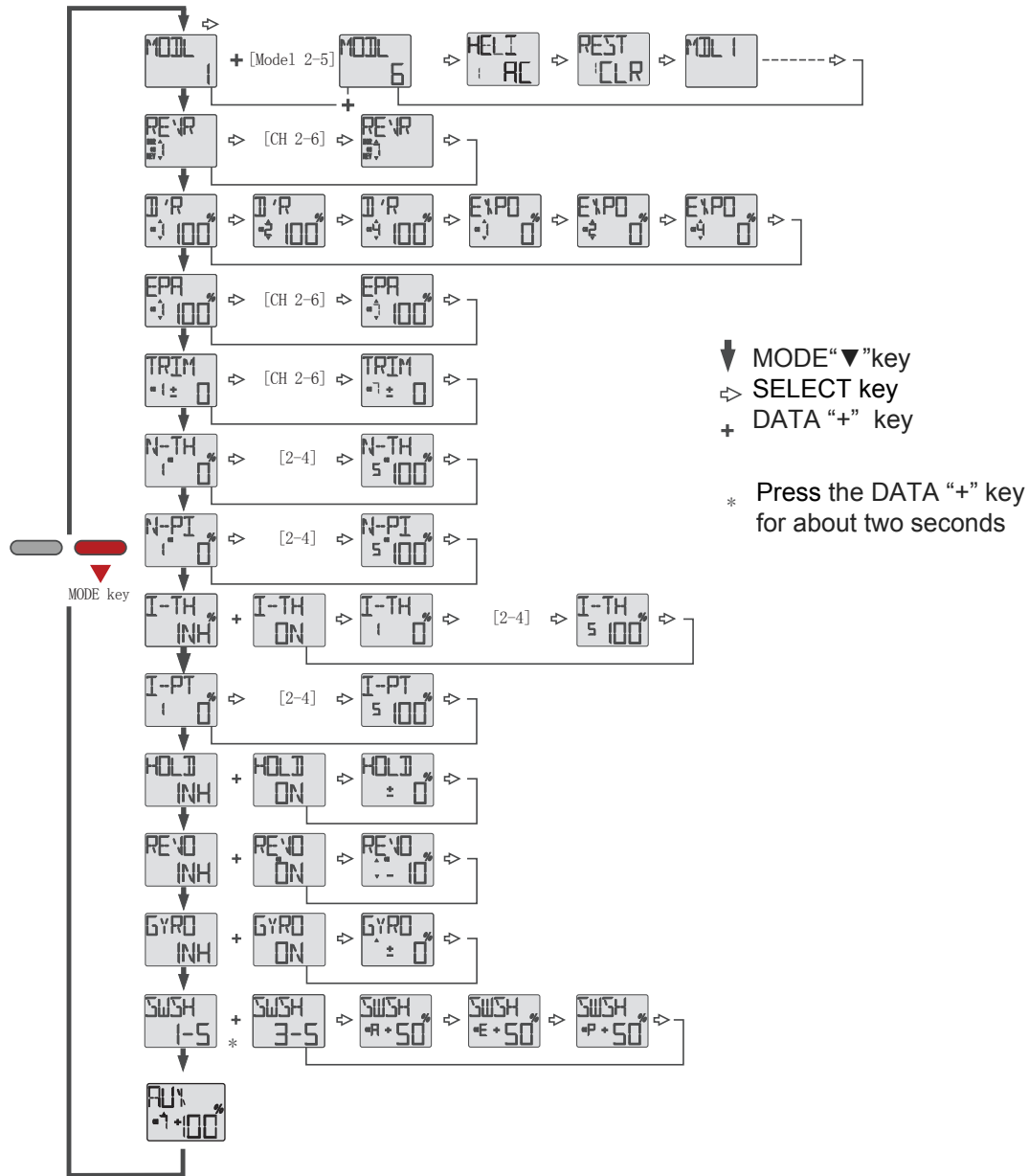

Simultaneously press the MODE “▲” and “▼” keys and hold them down for one second to enter the programming mode. Press the keys again (or turn off the transmitter) to exit the programming mode.

OTHER T7F-2.4GHz FUNCTIONS

Trainer switch

To utilize the trainer function, the appropriate trainer cord (available separately) and a second RadioLink transmitter (usually provided by your flight instructor or R/C club) will be required. When two radios are connected with the trainer cord, they are both capable of operating the model, but it's usually best for the instructor to hold the radio that has been setup for the plane to be flown (as it is already programmed to fly the model). When the instructor holds the trainer switch on his radio, the student will have control. When the instructor wishes to regain control he simply releases the switch. Then he will have immediate, full control.

To use the trainer function:

1. It is best for the instructor to use the transmitter that is already set up for the model to be flown.
2. If the student's radio has PCM/PPM capability, set it to PPM.
3. If the student's radio has a plug-in RF module, remove the module.
4. Collapse the student's antenna when the student's transmitter is conventional type. (29-72MHz)
5. With the transmitters off, connect the trainer cord to both radios. Do not force the plug into the transmitter and note that the plug is "keyed" so it can go in only one way.
6. Turn on the instructor's transmitter. DO NOT turn on the student's transmitter. It will automatically "power up," but will not transmit a signal. Set the servo reversing and trims of the student's radio to match that of the instructor's.
7. Turn on the receiver switch in the model. Depress the trainer switch on the instructor's radio. Use the student's radio to operate the controls (ailerons, elevator, rudder, etc.) and observe how they respond. Make any adjustments necessary to the student's transmitter to get the controls to respond correctly.

Simulator/Trainer Jack

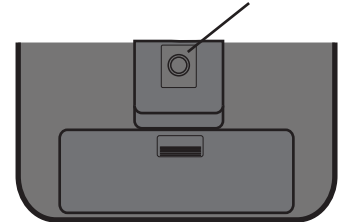

Note: When the instructor initially depresses the trainer switch on his transmitter, there will be a little delay before the student takes control. In most situations this momentary delay will go unnoticed.

NOTE:When using simulator function in the mode of helicopter, the SWSH should be adjusted to '1-S'.

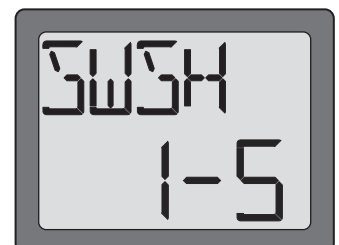

Adjustable-height control sticks

The control stick height is adjustable to make the transmitter more comfortable to hold and operate. To adjust the height, firstly use the 3mm inner hexangular wrench (C) to unlock screw (A) counterclockwise. Having got desired control stick height through turn the piece (B) counterclockwise or clockwise, then lock screw (A) clockwise.

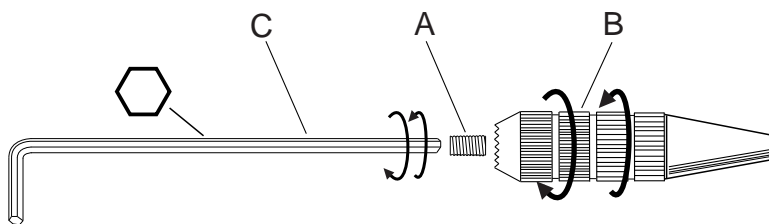

Changing the T7F-2.4GHz stick mode

The transmitter may be operated in four different stick “modes” (1, 2, 3 & 4). The modes determine the functions that will be operated by control sticks. Currently, the transmitter is in “mode 2” and should be left in mode 2 unless you are an experienced flyer and have learned to fly in a different mode. In mode 2, the right control stick operates the aileron and elevator and the left stick operates the rudder and throttle. This is how 99% of Americans fly their models.

To change the mode, simultaneously depress the MODE “▲” and “▼” keys, then turn on the power. The current mode will appear on the LCD screen. Press the DATA “+” or “-” key to change the mode. If a mode is selected that moves the throttle control to the right stick, the throttle detent mechanism will have to be moved as well. Please visit our website (<http://www.radiolink.com.cn/doce/download-default.html>) and download the file of Manual for changing Mode for 6CH radio for operation details.



FLIGHT PREPARATION

Flight preparation is to be done at the flying field.

If you are an inexperienced pilot, be certain your flight instructor performs these following checks with you.

Check the controls

1. Mount the wing to the fuselage. Turn on the transmitter, then the receiver (remember to do this in reverse order when turning off the system). Be certain the correct model memory matching the model you will be flying is the one on the LCD screen.
2. Operate and observe the controls. Look for inadvertent movement and listen for abnormal servo sounds. If problems are noted, correct them before flying. Look for binding pushrods or servo arms or pushrods that interfere with each other.
3. One at a time, operate each control on the airplane using the sticks on the transmitter to make certain each control is responding correctly. This must be done before every flight. (There are several types of malfunctions that can be discovered by performing this elementary task, thus saving your model!)

Do not fly in the rain!

Moisture may enter the transmitter through the antenna or stick openings and cause erratic operation or loss of control. If you must fly in wet weather during a contest, be sure to cover the transmitter with a plastic bag or other waterproof cover.

MODEL DATA RECORDING SHEET

After finalizing the programming for each model, fill out the values and settings in the Model Data Recording Sheets in the back of the manual. The data sheets will serve as a backup in case a program is ever lost or inadvertently reset, or in case you have to intentionally reset a program to make room for another model. Make additional copies before filling out the sheets.

MODEL DATA RECORDING SHEET (ACRO)

(Make copies before using)

Model name: _____

Model No. 1 • 2 • 3 • 4 • 5 • 6

Model Type: ACRO

MENU FUNCTION	CH 1	CH 2	CH 3	CH 4	CH 5	CH 6	CH 7
REVR Servo Reverse	N • R	N • R	N • R	N • R	N • R	N • R	N • R
D/R Dual Rate setting	▲ %	▲ %		▲ %			
	▼ %	▼ %		▼ %			
EPA End Point Adjust	▲ %	▲ %	▲ %	▲ %	▲ %	▲ %	▲ %
	▼ %	▼ %	▼ %	▼ %	▼ %	▼ %	▼ %
TRIM Trims							
EXPO Exponential setting	▲ %	▲ %		▲ %			
	▼ %	▼ %		▼ %			

MIXING SETTING

PMX1	Programmable Mixer 1	INH • ON	Master Ch ____ Slave Ch ____ Rate- ± ____% Sw ____
PMX2	Programmable Mixer 2	INH • ON	Master Ch ____ Slave Ch ____ Rate- ± ____% Sw ____
FLPR	Flaperon	INH • ON	Ailerons differential rate ± ____%
V-TL	V-Tail	INH • ON	CH 2 (Elevator) rate- ± ____% CH 4 (Rudder) rate- ± ____%
ELVN	Elevon	INH • ON	CH 1 (Aileron) rate- ± ____% CH 2 (Elevator) rate- ± ____%

FLAP TRIM SETTING

FLTR	Flap Trim	INH • ON	Flap trim rate ▲ ± ____% ▼ ± ____%
------	-----------	-----------------	------------------------------------

MODEL DATA RECORDING SHEET (HELI)

(Make copies before using)

Model name: _____

Model No. 1 • 2 • 3 • 4 • 5 • 6

Model Type: HELI

MENU FUNCTION	CH 1	CH 2	CH 3	CH 4	CH 5	CH 6	CH 7
REVR Servo Reverse	N • R	N • R	N • R	N • R	N • R	N • R	N • R
D/R Dual Rate setting	▲ %	▲ %		▲ %			
	▼ %	▼ %		▼ %			
EPA End Point Adjust	▲ %	▲ %	▲ %	▲ %	▲ %	▲ %	▲ %
	▼ %	▼ %	▼ %	▼ %	▼ %	▼ %	▼ %
TRIM Trims							
EXPO Exponential setting	▲ %	▲ %		▲ %			
	▼ %	▼ %		▼ %			

MIXING SETTING

N-TH Normal Throttle Curves		P-1 _____% P-2 _____% P-3 _____% P-4 _____% P-5 _____%
N-PI Normal Pitch Curves		P-1 _____% P-2 _____% P-3 _____% P-4 _____% P-5 _____%
I-TH Idle-UP Throttle Curves	INH • ON	P-1 _____% P-2 _____% P-3 _____% P-4 _____% P-5 _____%
I-PI Idle-UP Pitch Curves	INH • ON	P-1 _____% P-2 _____% P-3 _____% P-4 _____% P-5 _____%
HOLD Throttle Hold	INH • ON	Throttle hold position ± _____%
REVO Pitch-Rudder Mixing	INH • ON	▼ ± _____% ▲ ± _____%
GYRO Gyro Mixing	INH • ON	▼ ± _____% ▲ ± _____%
SWSH Swashplate Types	1-S • 3-S	CH A (Aileron) ± _____% CH E (Elevator) ± _____% CH P (Pitch) ± _____%

